

Maxonic 万讯
SHENZHEN MAXONIC AUTOMATION CONTROL CO., LTD.
深圳万讯自控股份有限公司

! "#\$% &'()*
+ , - . : ;
!!! " # \$ % & ' () * + , - . : ;
/(01 %&! !
201 & ! ! 3456 ' ((

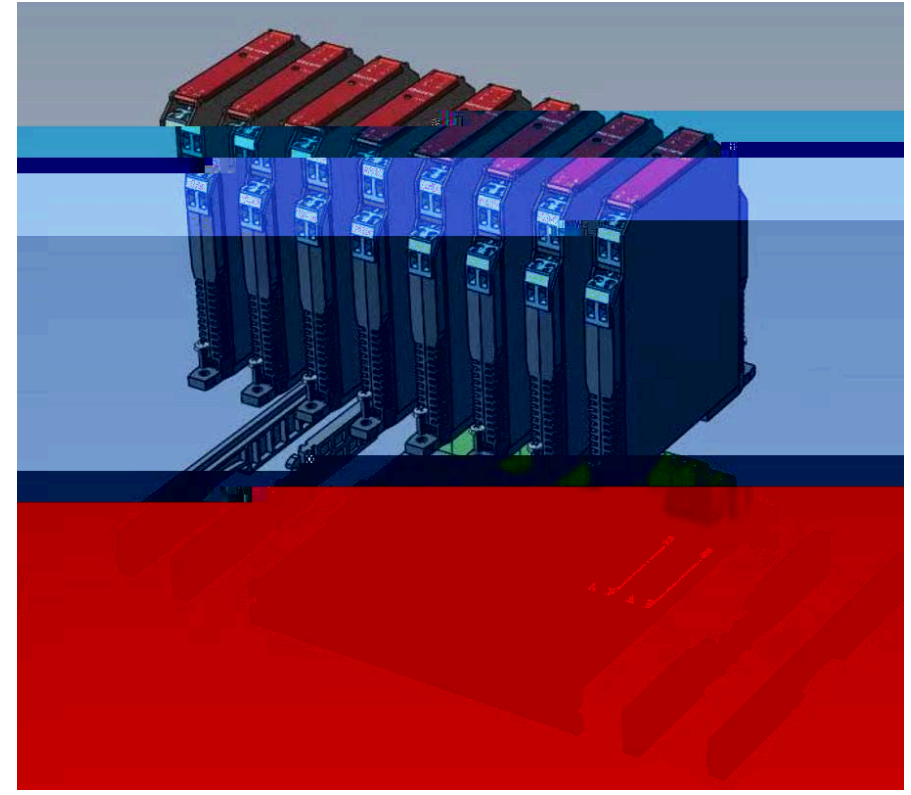

Maxonic 万讯

'(789:;<=>

?@A BC	DEF C	DEF GH	IJKLMNOP	PQ
)))	RM ST	
)))	UV	'
			WXYZ	
' [\] ^ _ ` a * A	(+(+bA c+de (f (ag (f a	* A `fh + i	
' [\] ^ _ ` a * A	+(+bA c+de (f ag f a	* A `fh + i	
' [\jH]^_`a * k , - IA	(+	+bA c+dek , - l (f (a	* k , - IA `fh + i	((
' [\jH]^_`a * k , - IA	+	+bA c+dek , - l (f ag f a	* k , - IA `fh + i	(
' [\] ^ _ ` a * m (* . nA	(+	A opde (f (ag (f a	* m (* . nA `fh + i	(
' [\] ^ _ ` a * m (* . nA	+	A opde f a	* m (* . nA `fh + i	('
' [\] ^ _ ` a * k , - IA	(+'	+bqrdek , - l (f (ag f a	* k , - IA `fh + ik / 0 Ysl	(
* A `f htuvX_	(1(+bA de (f (a	1 i`a * A	(
* A `f htuvX_	1(+bA de (f ag f a	1 i`a * A	(
* , - A `f hjHtuvX_	(1	+bA dek , - l g (f (a	1 i`a * k , - A	
* , - A `f hjHtuvX_	1	+bA dek , - l (f ag f a	1 i`a * k , - A	(
* m (* . nA `f htuvX_	(1	A opde (f (ag (f a	1 i`a * m (* . nA	
* m (* . nA `f htuvX_	1	A opde f a	1 i`a * m (* . nA	
* , - A `f hjHtuvX_	(1'	+bqrdek , - l (f (ag f a	1 i`a * k , - A	'
wxyzm(w) `ayzA	(2+(yzA de (f (ag (f a)+_ - A `fh 2+i	
wxyzm(w) `ayzA	2+(yzA de f a)+_ - A `fh 2+i	
wxyzm(w) `ayzA	(2+	yzA de (f (ag (f a	*+€y&A m ` `fh 2+i	' ++A
wxyzm(w) `ayzA	2+	yzA de f a	*+€y&A m ` `fh 2+i	' ++A

?@A BC	DEF C	DEF GH	IJKLMNOP	PQ
(. \$ `f h+,tmf_n_	(21(yzA de (f (a	21 i`a(w A m ` `fh ++A	
(. \$ `f h+,tmf_n_	21(yzA de f a	21 i`a(w A m ` `fh ++A	(
(. \$ `f h+,tmf_n_	(21	yzA de (f (a	21 i`a(w A m ` `fh ++A	
(. \$ `f h+,tmf_n_	21	yzA de f a	21 i`a(w A m ` `fh ++A	
)+_ - ...wh +,tmf_n_†&	21	yzA de (f (ag f a	21 i`a ` `fh ++A	'
((. \$ `f h+,tmf_n_	21'	yzA de (f (a	21 i`a(w A m ` `fh ++A	
‡^-%_`a Š+mŠ+CEA	(3(‡^-`^ (f (ag (f a	* m (* . nA `fh + i	
‡^-%_`a Š+mŠ+CEA	3(‡^-`^ f a	* m (* . nA `fh + i	
‡^-%_`a Š+A	(3	Š+A de (f (a	Š+A `fh + 4 i	'(
‡^-%_`a Š+A	3	Š+A de (f ag f a	Š+A `fh + 4 i	'
‡^-%_`a Š+CEA	(3	Š+CEA de (f (ag (f a	Š+CEA `fh + 2 i	'
‡^-%_`a Š+CEA	3	Š+CEA de (f ag f a	Š+CEA `fh + 2 i	"
R(*Ž`a R(A	(45(R(A de (f (a	R(A `fhR(i	'
***Ž`a **A	(4(**A]^de (f (ag (f a	* m (* . nA `fh + i	'

“” “” — “”
“” “”
“” “”
“” “”
“” “”
“” “”

Ⓜ (+ 4 4 6
((“g” ‘ ±²³
(“g” ±²³
+ c+deFg’µ , -
4 4 `f (f a (a . Q
,RCK’GHDECI
6 UVsk» U V¼z½TI

!“
+r¾z +rAw¾ z
+,µÁ Ã 78 (ÃÆ¶\ Ç È
ÉÊË•Ž+,µÁÏ
İ+ ÑŎ+g 0. Ów-Ŏ+ ‘0.
ÔÕŎ +r[g 0. ÓA[g (0.
2x+r[g 0. Ó+ r [[(0. Ó
A[g (0.
Ø• (.
ÙÚÛ ÜÝÞÀÑŔÈĎ@àgáää
ÙÚ ä qšæçŒègqé”èè_T
;îÁĚŔŔ ¶ ïð

#\$%&
©±ˆ ñ
òó± ^ ‘ ñ
¼éôˆ (ñ 9-,
)Ŋ ò ò ñ (03

(86 6)

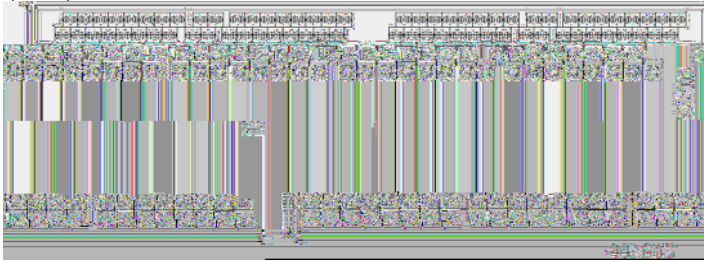

(86 6)

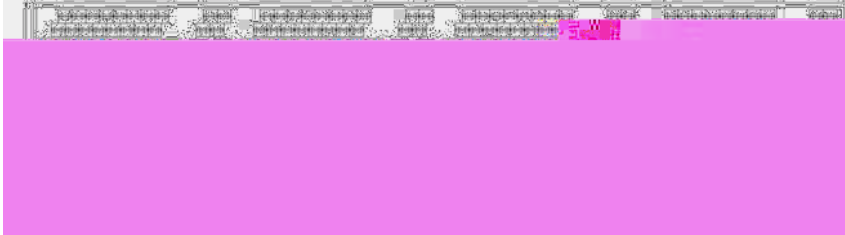

-3



4567

!

01

ĐYZÓ;UV...w_g

q+&

C	k)!)"l
(+(6 (()()(
+(6 (()()(

89.;

" !

01

@áĚ [m [ʲH]^_ ©²+rg]^_`aĚ+bA g de4
 `ah 246 3;4 ð ūM ' [ʲ]^_`aĚ+bA deðū» (f (ađ

[m [m ' [ʲH]^_g '* A

C	`f (`f	`a (`a
(+(44	*'	q	*'	q
(+(42	*'	q	6+<= '*	q

<=

`ly&+ōg

Ý >" 7? 4
 k²³ l
 :@ . :@ . +@
 3 @ (A 4 @ ;@ '
 k²³ (l
 :@ . :@ (. +@(
 3 @ A 4 @ B ;@ ,
 ©²+r ñ .24 gG C(A
 `fA Kg ' [g ' ñ
 c++ō (ñ . g +œ D
 c+¾;ž) &+bg '

`fœ +b'fg C D
 `aA DEKg ' ñ
 `a * D
 `aA DEKg 6+<= ' ñ
 `a†& †& ++ō ā (* .24
 ¥! \$ C (9 6 k • +B C(B l
 †žŸ C 9 6
 +Ñde `f +rgf `ag
 `TMš`f `ag E .4 k (l
 `f +rg E .4 k (l
 `a +rg E .4 k (l
 `TM+œ`f `a +rg E 5D k .24 l

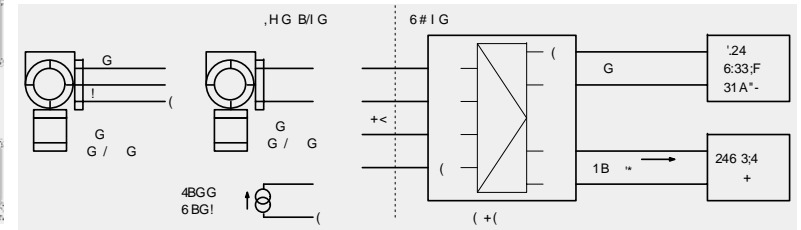

89.;;

" !

01

@àË [\m [\`jH]^_ ©²+rg]^_`aË+bA g de4`ah 246 3;4 ð ùM ' [\`jH]^_`aË+bA deð `è +deCðù» (f (að

[\m [\m ' [\`jH]^_g * A

C	`f (`f	`a (`a
(+(4 4 13(*		q	*	q
(+(4 2 13(*		q	6+<= *	q

<=

Ý >" 7? 4
 k²³ I
 :@ . :@ . +@
 3@ (A 4 @ ;@ ' ,
 k²³ (I
 :@ . :@ (. +@(
 3@ A 4@ B ;@ ,

©²+r ñ .24 gG C(A
 `fA Kg ' [g ' ñ
 c++ð (ñ . g +OE D
 c +¾¿) &+bg ' .

ly&+ðg .
 `fOE +b'fg C D
 `aA DEK g ' ñ
 `a * D
 `aA D E Kg 6+<= ' ñ
 `a†&†& ++ð ã (* .24
 ¥! \$ C (9 6k • +B C(B I
 †zÿ C 9 6
 +Ñde`f +rg`f `a g .
 TMS`f `ag E .4 k (I
 `f +rg E .4 k (I
 `a +rg E .4 k (I
 TM+ OE`f `a +rg E 5D k .24 I

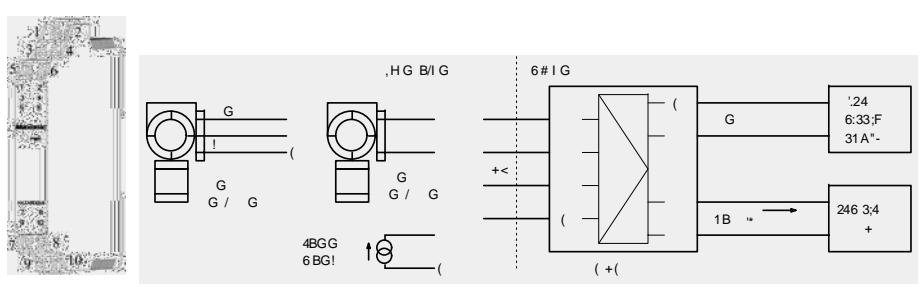

89.;;

>?@A

" !

01

@àË [\`jH]^_ ©²+rg]^_`aË+bA g de4`ah 246 3;4 ð ùM ' [\`jH]^_`aË+bA deð M çyz* `fA Yskc+mdeI ðù» (f (a¶ (f að

[\m ' [\`jH]^_g * A

C	`f (`f	`a (`a
(+(4 4 6A(*		q	*	q
(+(4 44 6A(*		q	*	*
(+(4 2 6A(*		q	6+<= *	q
(+(4 22 6A(*		q	6+<= *	6+<= *

<=

Ý >" 7? 4
 k²³ I

89.;

& 89.;; B # C

01

@àĚ [N^_ ©²+rg]^_aĚ+bAk'µ , - l g de4`
 ah 246 3;4 ð©²+r 7 a†&gŪoi Ě+rð Ýn >" & 7&? 4 ðŪ» (f (a¶
 f ađ

[N]H^_¶[j]H^_g * , - A ð

C	`f (`f	`a (`a
(+' 44 *	, -	q	* , -	q
(+' 4444 *	, - * , - *	, - * , - *		

<= c+¾ł) &+bg
 Ý >" & 7&? 4 !y&+ðg .
 k²³ ¶²³ (l `aA DEKg 'ñ , - g / 0 Ys
 :@ . :@ . +@ ¥! \$ C 9 6 k • +BC(B l
 3 @ ' A 4 @ ; @ , ‡^žŸ C 9 6
 L /
 ©²+r (ñ .24 g`a²A + +Ñde`f `ag .
 `fA Kg [g 'ñ , - ™š`f `ag E .4 k (l
 c++ð (* . ™+œ`f `ag E 5D k .24 l

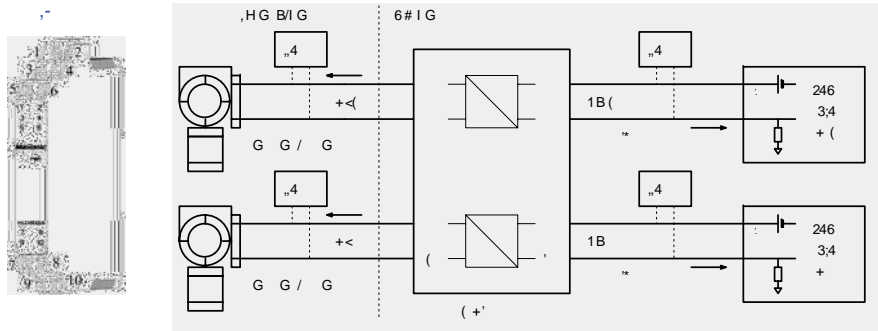

F\$.;G %

01

w 246 3;4 `aĚ+bA g de4`ah @àg8'jHtuvX_ðŪ» (f (ađ

jHtuvX_g * A

C	`f (`f	`a (`a
(1(44 *		q	* , -	q

<= `aA Kg 'ñ
 Ý >" 7? 4 `a * D
 k²³ l ¥! \$ C 9 6 k • +BC(B l
 :@ . :@ . +@ ‡^žŸ C 9 6
 3 @ (A 4 @ ; @ , L /
 ©²+r ñ .24 gG C(A +Ñde`a +rg`f `ag .
 `fA DEKg 'ñ ™š`f `ag E .4 k (l
 `fœ +b`fg C D `f +rg E .4 k (l
 ™+œ`f `a +rg E 5D k .24 l

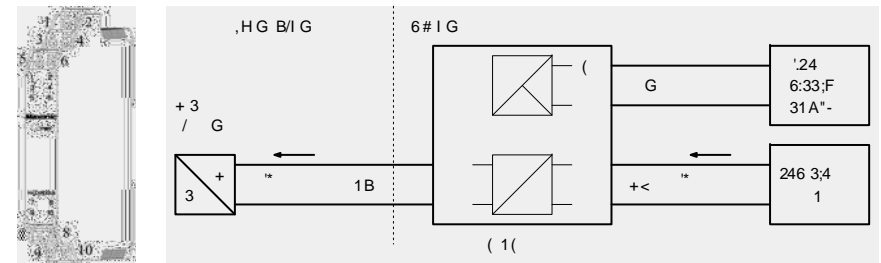

F\$.;G

%

01

w 246 3;4 `aË+bA g
deCðú» (f (að

de4'ah

@àg8\jHtuvX_ð "ê

+

jHtuvX_g

*

A

F\$.;G B # C
%

01
w 246 3;4 `aE+bA k'μ , - l g de4'ah @àg8'jHtuvX_δ
ùM 'jHtuvX_δ"ê ;'a[&y& & ÀGHðú» (f a¶ f ađ

jHtuvX_¶'jHtuvX_g * , - A

C	`f (`f	`a (`a
1 4 44 *	, -	q	* , - *	
1 4444 *	, - * , - *	* , - * , -		

<=
Ý ≥ 7? 4
k²³ (((¶ (' (l
: @ . : @ . + @
3 @ (A 4 @ ; @ ' ,
`a (* D g M , - E D
& Á`at& C mE(0 g'ft&+
b '
¥! \$ C (9 6 k • +BC(B l
‡^žŸ C 9 6

©[®]+r ñ .24 gG C(A
`fA DEKg 'ñ , -
`f Æ +b'fg C D
`aA Kg 'ñ , -
+Ñde`a +rg'f `ag .
™š`f `ag E .4 k (l
`a +rg E .4 k (l
`f +rg E .4 k (l
™+Æ` f `a +rg E 5D k .24 l

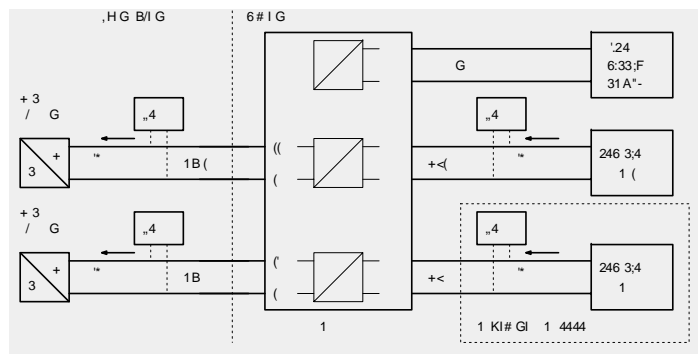

\$ F\$.DE
% %

01
w 246 3;4 `aE b+ôm+bA g opden 4g'ah @àg8'jHt
uvX_δú» (f (a¶ (f ađ

'jHtuvX_g° b+ôm+bA đ

C	`f (`f	`a (`a
(1))) ÷·Qø	q) ÷·Qø) ÷·Qø

·Qø

(* (.24	'	* (.24	4	* 24
* .24		*(24	7	g v
(* .24	8	* 24		qA

»C ®
(¶f * g'a (*(. gq'a g C (1 4'
¶f * g'a (* g'a *(. g C (1 4 4'
Û C (1 4 4 È"èg'pì » (1(4 4

<=
Ý >" 7? 4
k²³ ¶²³ (l
: @ . : @ . + @
3 @ (A 4 @ ; @ ' ,
`a +b'ag * D
+ô'ag E(OD
¥! \$ C (9 6
• +BC(B g .BC .
‡^žŸ C 9 6
L /
+Ñde`a +rg'f `ag .
™š`f `ag E .4 k (l
`a +rg E .4 k (l
`f +rg E .4 k (l
`a (`a g E .4 k (l
™+Æ`f `a +rg E 5D k .24 l

©[®]+r ñ .24 gG C(A
`fA DEKg b+ôm+bA
`fÆ +b'fg C D
+ô'fg E(OD
`aA Kg b+ôm+bA
+Ñde`a +rg'f `ag .
™š`f `ag E .4 k (l
`a +rg E .4 k (l
`f +rg E .4 k (l
`a (`a g E .4 k (l
™+Æ`f `a +rg E 5D k .24 l

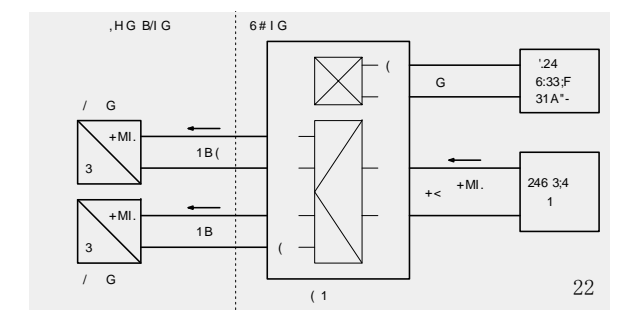

\$ F\$.DE
% %

01

w 246 3;4 `aE b+õm+bA g opden 4g`ah @äg8\jHt
uvX_ðû» f að

jHtuvX_g° b+õm+bA ð

C	`f (`f	`a (`a
1)))) ÷-Qø) ÷-Qø) ÷-Qø) ÷-Qø
-Qø				
(*.24	'	*(.24	4	* 24
*.24		*(24	7	g v
(* .24	8	* 24		

»C ®
`f ('* g'a (*(. Óa *. g'a *(g C 1 4'
Û C 1 4444 È'égøì » 1(4444

<= `a +b`ag * D
Ý >" 7? 4 + ð `ag E(0D
k²³ ((¶²³ ('(l ¥! \$ C (9 6
:@ . :@ . +@ • +BC(B g .BC .
3 @ (A 4 @ ;@ ', ‡ ž Ÿ C 9 6
L /
©^a+r ñ .24 gG C A + Ñde `a +rg`f `ag .
`fA DEKg b+õm+bA ^™š ^ `f `ag E .4 k (l
`fCE +b`fg C D `a +rg E .4 k (l
+ ð`fg E(0D `f +rg E .4 k (l
`aA Kg b + õm+bA `a (`a g E .4 k (l
^™+CE`f `a +rg E 5D k .24 l

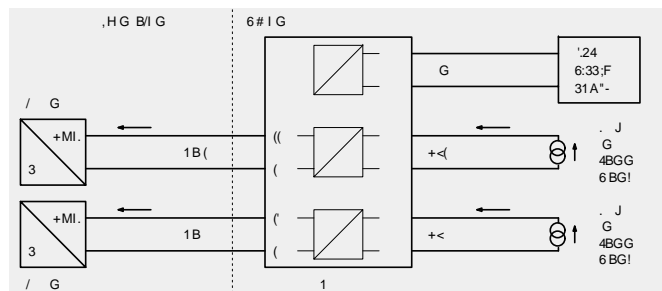
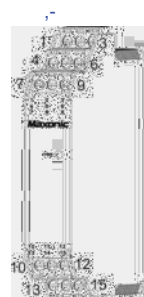

23

& F\$.;G B # C
% %

01

w 246 3;4 `aE+bA k'µ , - l g de4`ah @äg8\jHtuvX_ð
ûM `jHtuvX_ð©^a+r 7`fA gÛøì È+rõ Ýn >" &7&? 4 ðû» (f (a¶ f að

jHtuvX_¶jHtuvX_g * , - A ð

C	`f (`f	`a (`a
(1' 4 4	* , -	q	* , -	q
(1' 4444	* , - * , -	* , - * , -		

<= `f² +g ++ð . 24
Ý >" &7&? 4 `aA Kg 'ñ , -
k²³ ¶²³ (l `a * D
:@ . :@ . +@ ¥! \$ C 9 6 k • +BC(B l
3 @ ' A 4 @ ;@ ', ‡ ž Ÿ C 9 6
L /
`fA DEKg 'ñ , - +Ñde `f `ag .
`f+ð Û) k'a)` a+b . l ^™š `f `ag E . 4 k (l
^™+CE`f `ag E 5 Dk .24 l

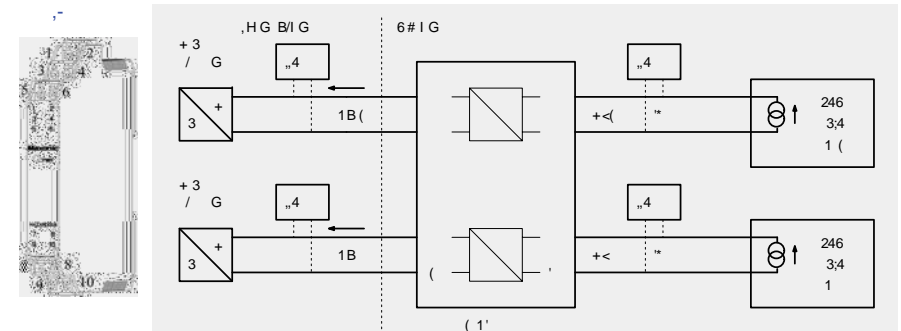

24

89.@AH

" #

01

À @àËwxyzm{w|A g
[&

de 4g a)+_~|A h

246 3;4 ð ;'f

89.@AH

" #

01

À @àËwxyzm{w|A g de4`ah 246 3;4 g a`µ•+€y&Ç! +•
 A ð ;f& ÅÇ GHðú» f að

< 5:- wxyzm{w|A ð

C	`f (`f	`a (`a
2+ ((wxyz m{w	wxyz m{w	•+€y&Ó ! ! +•	•+€y&Ó ! ! +•

<= `f &+b g N(9
 Ý >" 7? 4 ;"2 g+r
 k²³ (((¶ '((l ;" 2 g`a 1< Ó g`f[&
 : @. :@(. +@ (`a D E Kg+€y&m ! ! +•
 3 @ (A 4 @ ('B ; @ , `a+€y & ¶+ð . Ó)+b
 ©^{a+r} ñ .24 gG C A `a! +• !+• !.N 9 g +• *.
 `fA Kgwxym{w| op•• C0,H
 †&+b E (m` f +œ C 0Dø 1< +Ñde`f +rg f `ag .
 †&+b C(m`f +œE(0D ø 1 ™š`f `ag E .4 k (l
 [& Å †&+b E ø `f[& & `f +rg E .4 k (l
 †&+b C (ø `f [&y& `a +rg E .4 k (l
 `fy&+ðg .N(9 ™+œ` f `a +rg E 5D k .24 l

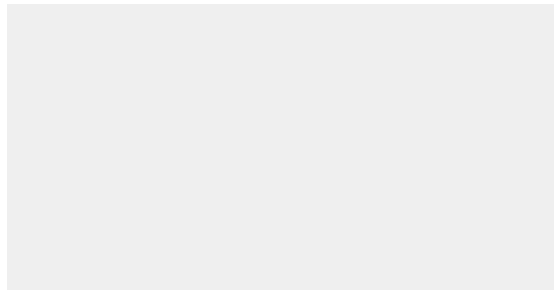

2+3 yz	1<	1
6A(`f (†& !+b g`a (1<	`f (†& +b g`a (1<
6A	`f †& !+b g`a 1<	`f †& +b g`a 1<
6A	`f ([&y&m & Å	Û `f ([&y&m & Å
6A'	`f [&y&m & Å	Û `f [&y&m & Å

F\$.@AH

' %

01

w 246 3;4 ĘyzA g'f'μ{w|A Ç! +•A g de4g ç @àË D
 +,tmf„_g'aG• (. \$ ð"ê ;'at&y& & ÁGHðú» f ađ

D+,tg Df„_

C	`f (`f	`a (`a
21(("	{w m•+€ y&Ó ' ! +•A	{w m•+€ y&Ó ' ! +•A	;r`ag (. \$;r`ag (. \$

<=

`a Kg ; r`ag (. \$

Ý >" 7? 4

k²³ (((¶ (' (|

:@ . :@ . +@
 3 @ (A 4 @ ; @ ',

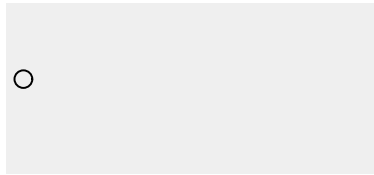

©ª+r ñ .24 gG C A

`f A DEKg~|A gm! +•A

`f~|A

`ft&+b E ø 1< g

`ft&+b Q ø 1

`fy&+õg .N(9

`f & +bg N(9

`f! +•A †&+b \$ '.24

`f+õ (* . ø 1<

`f+õ *. ø 1

[& Á `a[& & g ›

`a[&y&g

F\$.@AH

' %

01

w 246 3;4 ĘyzA g'f μ(w|A C! +*A g de4g ç @àĚ D
 +,tmf_n_g'aG• (. \$' ð'ê ;'at&y& & ĀGHðú» f ađ

D+,tg Df_n_

C	`f (`f	`a (`a
21 ("	{w m*+€ y&Ó ' ! +*A	{w m*+€ y&Ó ' ! +*A	;r`ag (. \$'	;r`ag (. \$'

<=

Ý >" 7? 4
 k²³ (((¶ (' (l
 :@ . :@ . +@('
 3 @ A 4 @ ;@ (,

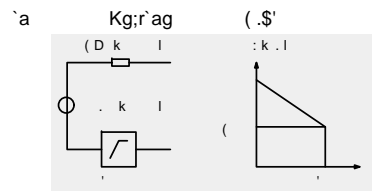

@^+r ñ .24 gG C A
 `fA DEKg~|A gm! +*A
 `f ~ |A
 `ft&+b E ø 1< g
 `ft& + b C(ø 1
 `fy&+õg .N(9
 `f &+bg N(9
 `f! +*A † &+b \$'.24
 `f+ð (* . ø 1<
 `f+ð *. ø 1
 [& Ā`a[& &g ›
 `a[&y&g

n +& `a Ā
 op** C(,H
 ;"2 g+r
 ;"2 g `a 1< Ó g`a[&
 çyz *ù x ;"2 Kg Ā`a[&
 •ù e ;"2 KgÛ Ā`a[&
 +Ñde `a +rg f `ag .
 ~TMŠ`f `ag E .4 k (l
 `a +rg E .4 k (l
 `f +rg E .4 k (l
 `f (`f ¶a (`a gÛde
 ~TM+CE`f `a + rg E 5D k .24 l

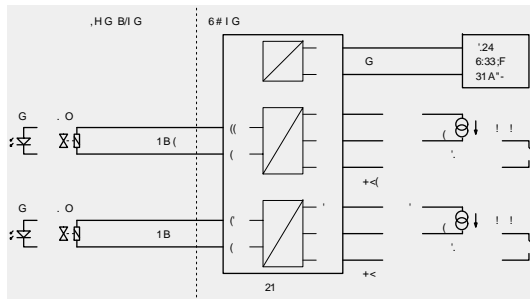

\$ F\$.@AH

' %

01

w 246 3;4 Ę! +*A g ç)+_g)+_~|...wh @àĚ DmdÝ+,tðŮ°
 ï Ę@^+rðŮ» (f (a¶ f ađ

dÝ+,t f_n_Ó D+,t f_n_

C	`f (`f	`a (`a
21 (' ! +* A	q)+_~ A	q
21 ((' ! +* A	' ! +* A)+_~ A)+_~ A

<=

Ý >" 7? 4
 k²³ (((¶ (' (l
 :@'.24 :@'. +@

.4 !/PQ
 '.24 CEĀ
 }+_~| M D•Ž
 .4 !/PQ
 '.24 CEĀ
 }+_ Ā Ò (/ /

`fA DEKg! +*A
 !+og (* .24 k l
)DE`f+ð '.24
 `a Kg }+_
 kM DIJ gâ...w•Ž DCI
 }+_~| M dÝ•Ž

}+_ (M M
 op** C(,H
 +Ñde `f `ag .
 ~TMŠ`f `ag E .4 k (l
 ~TM+CE`f `ag E 5D k .24 l

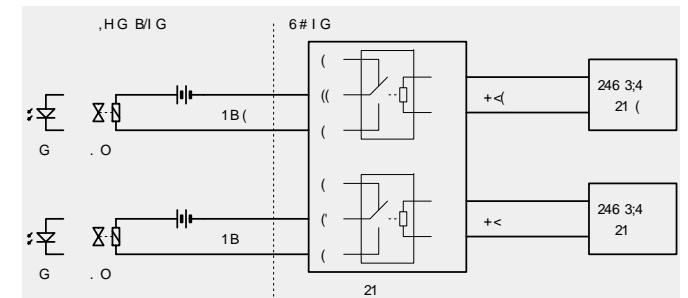
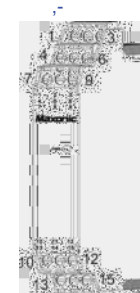

& F\$.@AH

01

w 246 3;4 ÈyzA g de4g ç @ãË D+,tmf_n_g `aG• ((.\$ ð
Ý >" 7? 8ð"è ;'at&y& & ÁGHóú» (f (aóÙ C ð

D+,tg Df_n_

C	`f (`f	`a (`a
(21' ('	{w m*+€y& q	;r'ag	((.\$	q
(21' ')	'! ! +*A	q ;r'ag	((.\$	q

<=

Ý >" 7? 8

k²³ l
:@ . :@ . +@ (
3@('A 4@'B ;@ (,

@ª+r ñ .24 gG C A
`fA DEKg-|A gm! +*A
`f-|A

`f †&+b E ø 1<g
`ft&+b C(ø 1
`fy&+õg .N(9
`f &+b g N 9
`f! +*A †&+b \$'.24
`f+õ (* . ø 1<
`f+ õ *. ø 1
[& Á`a[& &g)

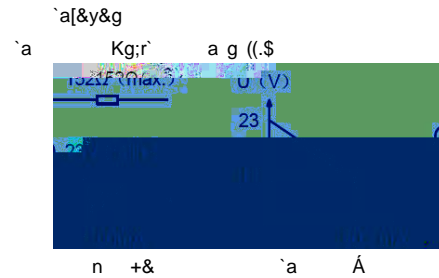

n +& `a Á
op** Q ,H
;2 g+r
;2 g'a 1<
+Ñde`a +rg`f `ag
™™g`f `ag E .4 k (l
`a +rg E .4 k (l
`f +rg E .4 k (l
™™+CE `f `a +rg E 5D k .24 l

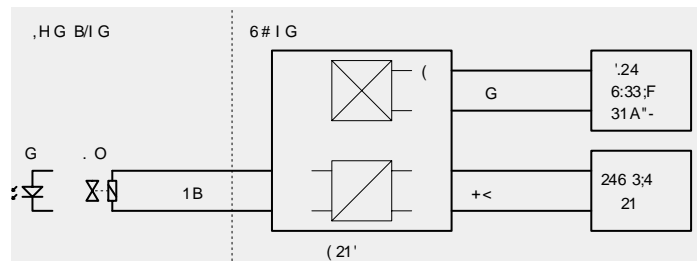

& F\$.@AH

01

w 246 3;4 ÈyzA g de4g ç @ãË D+,tmf_n_g `aG• ((.\$ ð
Ý >" 7? 8ð"è ;'at&y& & ÁGHóú» (f (aóÙ C ð

D+,tg Df_n_

C	`f (`f	`a (`a
21' ('	{w m*+€y& q	;r'ag	((.\$	q
21' ')	'! ! +*A	q ;r'ag	((.\$	q

<=

Ý >" 7? 8

k²³ ((l
:@ . :@ . +@ (
3@('A 4@'B ;@ (,

@ª+r ñ .24 gG C A
`fA DEKg-|A gm! +*A
`f-|A

`f †&+b E ø 1<g
`ft&+b C(ø 1
`fy&+õg .N(9
`f &+b g N 9
`f! +*A †&+b \$'.24
`f+õ (* . ø 1<
`f+ õ *. ø 1
[& Á`a[& &g)

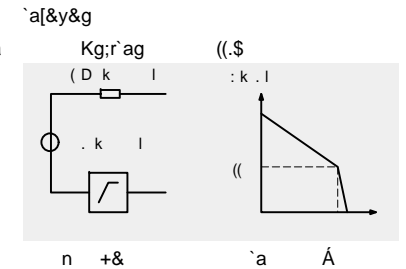

n +& `a Á
op** Q ,H
;2 g+r
;2 g'a 1<
+Ñde`a +rg`f `a g
™™g`f `ag E .4 k (l
`a +rg E .4 k (l
`f +rg E .4 k (l
™™+CE`f `a +rg E 5D k .24 l

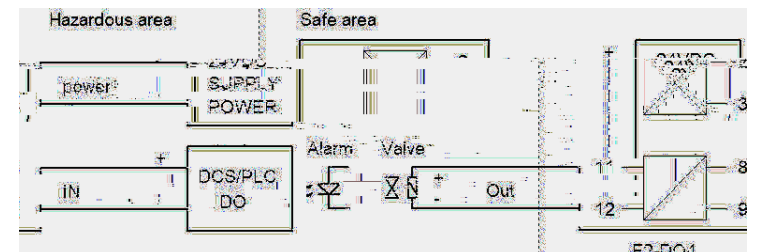

IJKL

%

01

w @àĚŠ+◀mŠ+ĈE-%_A g opden 4gah 246 3;4 ðùù!• -
 %_BCÇ†ˆ āðˆê ;f ĀGHgú• `aðù» (f (ag (f ađ

◦ Š+◀mŠ+ĈEð

C	`f (`f	`a (`a
(3(R))	R ÷-Qø (q) ÷-Qø) ÷-Qø

·Qø ((= CŠ+◀	' 8 CŠ+◀	SCŠ+◀	7 g v
	6 CŠ+◀	- CŠ+◀	< CŠ+◀	
	" CŠ+◀	CŠ+◀	3(CŠ+ĈE	

·Qø	(*.24	' *.24	4	*.24
	*.24	*(24	7	g v
	(*.24	* 24		qA
F)+_`akf,,l				

»C @ (¶f = CŠ+g'a (*(. gq'a g C (3(' ¶f 3(CŠ+ĈEg'a ('* g'a *(. g C (3(4' ¶f oĩ v†ˆ āg a k 3(g * l•vð ¶f?@• †ˆ āÇ-%_BCĚg! ¶] [5+= ((U ¶]• T 4 #JU ð

<= ;'2 ` f lm g Ó g
 Ý >" 7? 4 `aA DEKg b+ðm+bA
 k²³ ¶ ¶ l `a +b`ag * D
 :@ . :@ . +@ +ð`ag E(0D
 3 @((A 4 @ (B ;@ , ¥! \$) ÷` fA ¥!ø
 • +B C(B g . BC .

©®+r ñ .24 gG C(A †ˆZŸ C (9 6
 `fA K g Š+◀mŠ+ĈE L (/ +N`de `f +rg`f `ag .
 Š+◀ [+ĈE C(D [+TMŠ`f `ag E .4 k (l
 Š+ĈE [+ĈE C D [`f +rg E .4 k (l
 Š+◀ 2 ¥! C(k èTI `a +rg E .4 k (l
 Š+ĈE + b C `a (`a g E .4 k (l
 [& Ā`f{& Āk'a û• l `a (`a g E .4 k (l
 ;'2 g+r +TM+ĈE`f `a +rg E 5D k .24 l

IJKL

%

MNO PQZ

-%_	`f ā	¥! \$
`fBC	Ā/Ē ā	- /Ē ~é¥! ¼é¥!
=	ñ (((9 6
6	ñ (((9 6
"	ñ (((9 6
8	(ñ (((9 6
-	ñ (((9 6
	ñ '	((9 6
S	ñ (((9 6
<	ñ (((9 6
3 (ñ	((9 6

NO]_Ě ^ ~é¥! ¼é¥!É~) Ó NO
 3 ((~é¥! g¼é¥! (V (9@ (g ¥! ~é¥! Ó
 3 (~é¥! g¼é¥! V (9@ g ¥! ¼é¥! ð

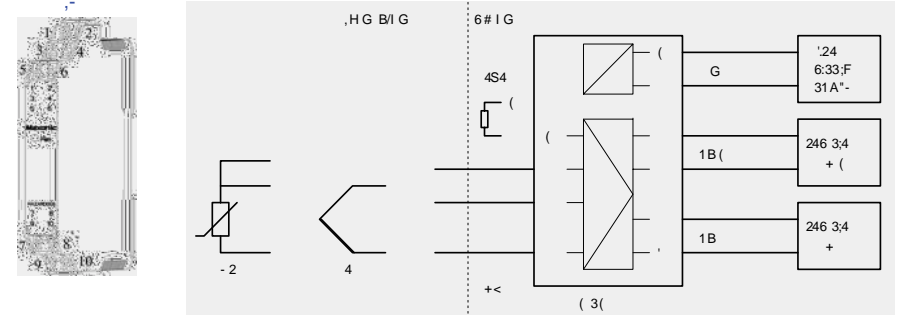

NO DEFhŠ+◀ Ě...[pM BCĚ [g)Ā/Ē¥!ð
 4S4 M Š+ĈĚ 2 g vù Mw[²³úgwŠ+◀ o]pM ²³ð
 DEFhŠ+ĈE Ě...[pM [á ^ g [+ĈE Ū)Ā/Ē¥!ð

R&SIKTU-)

01S M ...w (3(desDEFF 34 R(g (3(• -%_BCÇ)†ˆ ā
 ,S

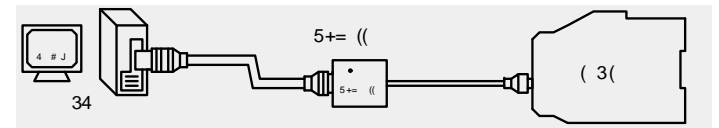

IJKL

%

01

w @àĚŠ+◀mŠ+ĈE-%_A g opden 4g ah 246 3;4 ðùù[• -
 %_BCÇ†ˆ āð"ê ;ˆf ĀGHgú• `aðù» f ađ

◦ Š+◀mŠ+ĈEð

C	`f (`f	`a (`a
3(R R))	R ÷·Qø (R ÷·Qø () ÷·Qø) ÷·Qø

·Qø (

(= CŠ+◀	' 8 CŠ+◀	SCŠ+◀	7 g v
6 CŠ+◀	- CŠ+◀	< CŠ+◀	
" CŠ+◀	CŠ+◀	3(CŠ+ĈE	

·Qø

(*(. 24	'	*(. 24 4	* 24
* . 24		* (24 7	g v
(* . 24 8		* 24 F	}+_`akf„l

»C © (¶f (= CŠ+g'a (" Óf " CŠ+g'a *(. g
 C 3((4'
 ¶ òi v†ˆ āg a k 3(g * l•vð
 ¶òù?@• †ˆ āÇ-%_BCĚgòl ¶] [5+= ((U ¶]•
 T 4 #JU ð

<=

Ý >" 7? 4
 k²³ (((¶ (((I
 : @ . : @ . + @
 3 @((A 4 @ (B ; @ ,

©ª + r ñ .24 gG C(A
 `fA Kg Š+◀mŠ+ĈE
 Š+◀ [+ĈE C D [
 Š+ĈE [+ĈE C D [
 Š+ ◀ ² ¥! C(k èTI
 Š+ĈE

V;WO

#

01

w @àĚŠ+< . A g de4'ah 246 3;4 đ'ê ;'f ĀGHgũ•
'ađũ» (f (ađ

° Š+<g . A đ

C	'f ('f	'a ('a
(3 ..	(.*((.	q	(.*((.	q

<=> [& Ā `f [& Ā
 Ý >" 7? 4 'f [' a ((.
 k²³ l ¥! \$ 9 6 m B.)
 :@ . :@ . +@
 3 @((A 4 @ (B ;@ ,
 • .BCB.
 ‡ž Ÿ C 9 6
 L /
 + Ñ de `f +rg`f `ag .
 ™Š~`f `ag E .4 k (l
 'f +rg E .4 k (l
 `a +rg E .4 k (l
 ™+œ`f `a + r g E 5D k .24 l

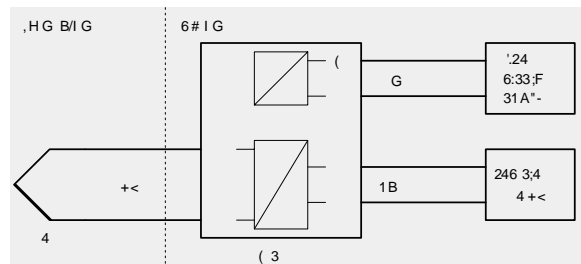

NO DEFhŠ+< Ě...[pM BCĚ [g)ĀÆ¥!đ

V;WO

#

01

w @àĚŠ+< . A g de4'ah 246 3;4 đ'ê ;'f ĀGHgũ•
'ađũ» (f a¶ f ađ

° Š+<g . A đ

C	'f ('f	'a ('a
3 ...	(.*((.	q	(.*((.	(.*((.
3	(.*((.	(.*((.	(.*((.	(.*((.

<=> [& Ā `f [& Ā
 Ý >" 7? 4 'f [a ((.
 k²³ (((¶ (' (l
 :@ . :@ . +@
 3 @((A 4 @ (B ;@ ,
 • .BCB.
 ‡žŸ C 9 6
 L /
 + Ñ de `f +r g `f `ag .
 ™Š~`f `ag E .4 k (l
 'f +rg E . 4k (l
 `a +rg E .4 k (l
 'f (`f gŪde
 ™+œ`f `a +rg E 5D k .24 l

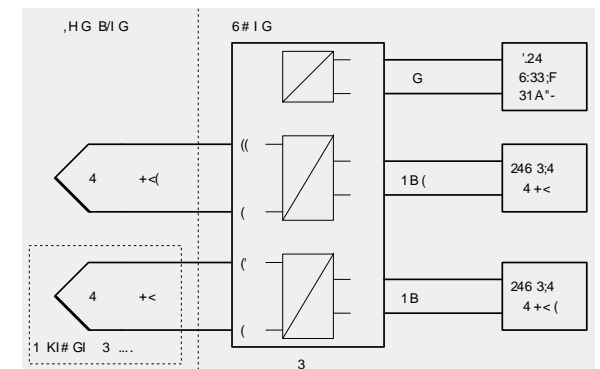

NO DEFhŠ+< Ě...[pM BCĚ [g)ĀÆ¥!đ

\$;XO

01

w @àÈŠ+ĈEA g de4'ah 246 3;4 ð'ê ;'f ĀGHġũ•
 `aðũ» (f (a¶ (f ađ

[Š+ĈEA ð

C	'f ('f	'a ('a
(3 (('*' D	q	'*' D	q
(3 ((('*' D	q	'*' D	q

<= 'a +b *
 Ý >" 7? 4 [& Ā f& Ā
 k²³ ¶ ¶ l 'f [`a ' D
 :@ . :@ . +@ ¥! \$ 9 6 m D)
 3@((A 4@ (B ;@ , • -BC D
 ‡^ žŸ C 9 6
 L (/ Ā + Ñ de `f +rg f `ag
 ©²+r ñ .24 g G C(A + Ñ de `f +rg f `ag
 `fA Kg [Š+ĈEg ' *' D + Ñ de `f +rg f `ag
 Š+ĈE [+ĈE C D ["™Š" 'f `ag E .4 k (l
 Š + ĈE +b C 'f +rg E .4 k (l
 `aA DEKg [Š+ĈEg ' *' D `a +rg E .4 k (l
 "™+ĈE`f `a +r g E 5D k .24 l

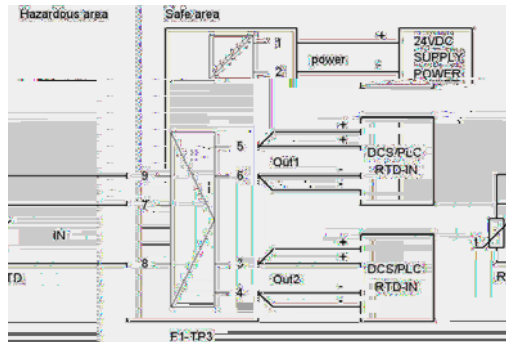

NO DEFhŠ+ĈE Ę...[pM [á ^ g [+ĈE Ū)ĀÆ¥!ð
 `aũw[' [g ¼ 4 øĀÆ Āg ūHŪ!pM [sđ
 `a .1.Ę+ĈEg +ð+b Āa Ę +ĈEg o j w[Ę €đ

\$;XO

01

w @àÈŠ+ĈEA g de4'ah 246 3;4 ð'ê ;'f ĀGHġũ•
 `aðũ» (f a¶ f ađ

[Š+ĈEA ð

C	'f ('f	'a ('a
3 (('*' D	q	'*' D	'*' D
3 ((('*' D	'*' D	'*' D	'*' D

<= [& Ā f& Ā
 Ý >" 7? 4 'f [a ' D
 k²³ (((((l 'f [a ' D
 :@ . :@ . +@ ¥! \$ 9 6 m D)
 3@((A 4@ (B ;@ , • -BC D
 ‡^ žŸ C 9 6
 L (/ Ā + Ñ de `f +rg f `ag
 ©²+r ñ .24 g G C(A + Ñ de `f +rg f `ag
 `fA Kg [Š+ĈEg ' *' D + Ñ de `f +rg f `ag
 Š+ĈE [+ĈE C D ["™Š" 'f `ag E .4 k (l
 Š+ĈE +b C 'f +rg E .4 k (l
 `aA DEKg [Š + ĈEg ' *' D `a +rg E .4 k (l
 `a +b * "™+ĈE `f `a +r g E 5D k .24 l

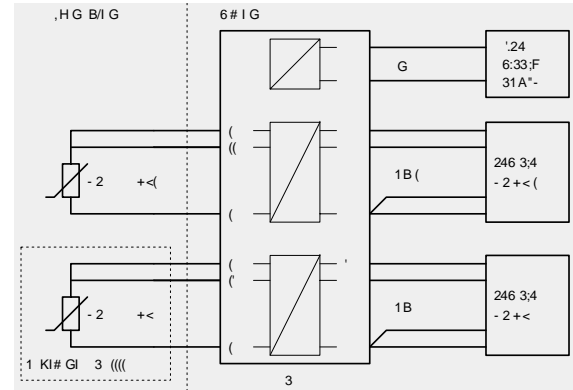

NO DEFhŠ+ĈE Ę...[pM [á ^ g [+ĈE Ū)ĀÆ¥!ð
 `aũw[' [g ¼ 4 øĀÆ Āg ūHŪ!pM [sđ
 `a .1.Ę+ĈEg +ð+b Āa Ę +ĈEg o j w[Ę €đ

YO

&*+

01

w @àĚ -6' R(A g de4'ah 246 3;4 ð ù (& (. deĚ D+
rg ?@R(•Ž©Mðú» (f (að

-6' øð

C	`f	c+	`a
(45(((-6'	q	-6'
(45(((-6' (.)	-6'	

<= A BC -6' ! A
 Ý >" 7? 4 c +y&+ð C .
 k²³ I `a g+ð E(.
 :@ . :@ . +@
 3 @ (A 4 @ B ;@ ,
 k²³ (I
 :@ . :@ . +@(
 3 @ A 4 @ ;@(
 ©^a+r ñ .24 gG C(A
 `fA Kg -6' A
 `aA DEKg -6' A
 +N̄de `f +rg`f `ag .
 ~TMš`f `ag E .4 k (I
 `f +rg E .4 k (I
 `a +rg E .4 k (I
 ~TM+CE`f `a +rg E 5D k .24 I

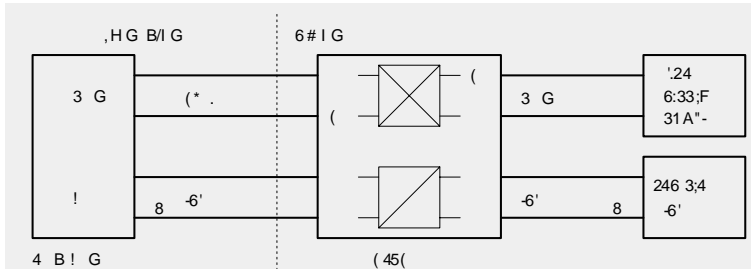

Z|KL

, !

01

w @àĚ•A gop •• @Ě b+ðm+bA g de4'ah 246 3;4 ð
 ùù|• •• äðú» (f (að

••A g < 5:- yz| | \ <3< 3<3 yzð

C	`f (`f	`a (`a
(4(R)	R ÷-Qø (q) ÷-Qø) ÷-Qø

(wxyz	[yz	7	g	v
--------	-----	---	---	---

(*(.24	'	*(.24	4	'* 24	q`a
*.24		* (24	7	g	v
(* .24	8	* 24	F)+_`a	

»C @ (f < 5:- wxyzg &`a *` g C (4((44 ð
 | | òj v•• äg a k *(0,H |vð
 |ù?@• •• äĚg| | [5+= ((U T•• T G %B !K4 #JU ð
 <= `fA Kg [yz `fg | | (+ðÖÖg *` !+*g *(. +•
 k²³ (I c+`ag `g (. \$ g`)a
 :@ . :@(. +@ Ž ù\ (. c+Ě`è k . \$ I
 3 @ A 4 @ ('B ;@ , •• ā (,H*(0,H
 k²³ (I • (,H
 :@ . :@ . +@ `aA DEKg b+ðm+bA
 3 @ A 4 @ ;@ '5 `a +b`ag *` D
 :@ . : @((. +@ +ð`ag E(0D
 3 @ A 4 @ ('B ;@ ,
 k²³ (I
 :@ . : @((. +@
 3 @ A 4 @ ('B ;@ ,
 +N̄de `f +rg`f `ag .
 ~TMš`f `ag E .4 k (I
 `f +rg E .4 k (I
 `a +rg E .4 k (I
 ~TM+CE`f `a +rg E 5D k .24 I

©^a+r ñ . 24gG C(A
 `fA Kg wxyz` f g | | (f g
 †&+b E (m`f+CE C 0Dø 1<
 †&+b C(m`f+CE E(0 Dø 1
 `fy&+ðg .N(9
 `f &+ b g (N(9

-

